



Single Genset Controller

SGC 110



1. Introduction	
1.1 About SGC 110.....	4
1.2 Key functions.....	4
1.3 Product overview.....	4
1.4 Passwords.....	5
1.5 Overview of controller buttons.....	5
1.6 Legal information.....	6
2. Safety instructions	
2.1 General safety instructions.....	7
2.2 Electrical safety.....	7
2.3 In operation safety.....	7
3. Technical specifications	
3.1 Terminals.....	8
3.2 Power supply.....	8
3.3 Genset voltage and frequency measurements.....	9
3.4 Digital inputs.....	9
3.5 Analogue resistive sensor inputs.....	9
3.6 Analogue inputs used as digital inputs.....	10
3.7 D+ Charger alternator.....	10
3.8 Sensor common point.....	11
3.9 Digital outputs.....	11
3.10 Communication ports.....	11
4. Installation	
4.1 Dimensions.....	12
4.2 Mounting in panel.....	12
4.3 Terminal details.....	13
4.4 Typical wiring diagram.....	15
5. Monitoring mode	
5.1 Monitoring mode.....	16
6. Configuration mode	
6.1 Configuration mode.....	17
6.2 Configurable parameters.....	17
6.2.1 Configurable parameters.....	17
6.2.2 Module.....	18
6.2.3 Digital inputs.....	18
6.2.4 Analogue inputs.....	19
6.2.5 Outputs.....	21
6.2.6 Timers.....	21
6.2.7 Generator.....	22
6.2.8 Engine.....	23
6.2.9 Maintenance.....	25
6.2.10 Password ID.....	25
6.3 Digital input source selection.....	26
6.4 Digital output source selection.....	26
7. Running modes	
7.1 Remote start/stop mode.....	28

7.2 Deep sleep mode.....	29
7.3 Manual mode.....	29
8. Alarms	
8.1 Alarms.....	30
9. Troubleshooting	
9.1 Troubleshooting.....	33

1. Introduction

1.1 About SGC 110

This document presents information necessary for operating DEIF's SGC 110 genset controller.

SGC 110 is a modern genset controller with user friendly HMI and full graphics LCD. The controller comes with a highly versatile software. Extensive inputs and outputs support a wide variety of industry standard features in diesel/gasoline genset applications.

The DEIF Smart Connect software offers flexibility to configure each individual input and output for a specific function or application. All parameters can also be configured on the controller.

1.2 Key functions

- Genset controller with configurable inputs:
 - Five digital inputs
 - Three analogue inputs
- Six digital outputs
- Monitors and controls the genset performance effectively
- Monitors genset output voltage and frequency precisely
- Remote start/stop
- Deep sleep mode to extend the battery lifetime
- Pre-heat output for assisting engine start
- PC connectivity via USB port for customised configuration
- Backlit full graphics display with power saving feature
- Log with the latest 30 events

1.3 Product overview

Following table gives a brief overview of SGC 110 features:

Features	Specifications
Digital switch input	5
Analogue resistive inputs	3
DG alternator voltage input, D+ charging alternator I/O	Yes
Digital outputs	6
Event logs	Yes
USB I/O port for laptop access	Yes
DC battery supply voltage (with -32 V reverse protection)	8 to 28 V
Operating temperature range	-20 to 65 °C
Protection class with gasket (included)	IP65









1.4 Passwords

The controller is protected from set-up changes with a four digit password.

There are two password levels:

Level	Access	Factory setting
1	Full access (read and write)	0123
2	Limited access (read)	1234

The passwords can be changed on the controller:

1. Go to Configuration mode.
2. Log on with password level 1.
3. Use the Up  and Down  buttons to go to Misc Settings, select with the Start  button.
4. Use the Up  and Down  buttons to go to the password to be changed, select with the Start  button.
5. Use the Up  and Down  buttons to choose the first digit for the new password, select with the Start  button.
6. Repeat for the next three digits.
7. When all four digits are chosen, the display shows

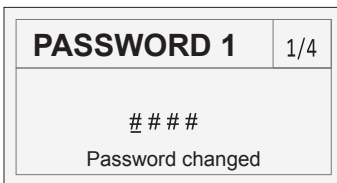

1.5 Overview of controller buttons

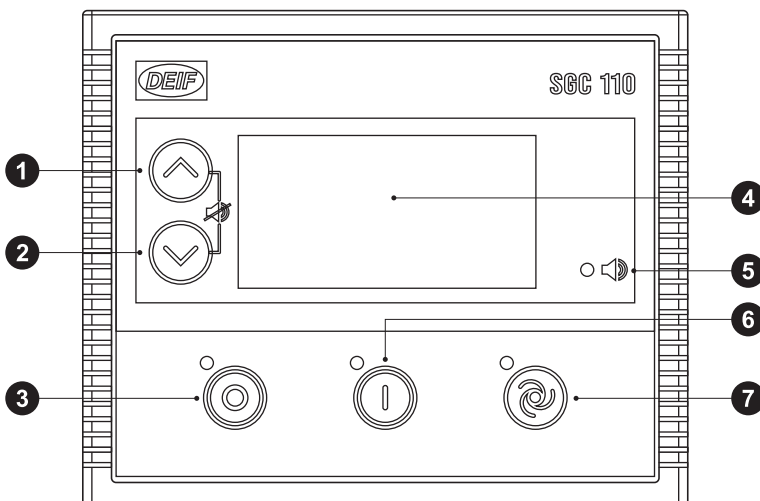

1. Menu navigation up button
2. Menu navigation down button
3. Stop/Config button
4. Display
5. Alarm LED
6. Start button
7. Mode selection button

Button functions

In Mode	Button input	Function
Manual	Start	Starts the engine
	Stop	Stops the engine
Manual	Stop (long press)	Enters Configuration mode
	Down + Stop (long press)	Enters Programming mode
Manual Auto Configuration	Up Down	Scrolls through the views/parameters
Manual Auto	Up + Down (during Alarm view)	Acknowledges and clears the alarm
Configuration	Start	Selects/saves the parameter
Configuration	Up + Down (long press)	Enters the Event log page
Configuration	Stop (long press)	Back to Manual mode
Deep sleep	Any Key (for min. 1 s)	Back to Manual mode
Event log page	Up + Down (long press)	Back to Configuration mode
Programming	Up + Down (long press)	Enters Manual mode

1.6 Legal information

Warranty



WARNING

The controller is not to be opened by unauthorised personnel. If the controller is opened anyway, the warranty will be lost.

Disclaimer

DEIF takes no responsibility for installation or operation of the generator set. If there is any doubt about how to install or operate the engine/generator controlled by the SGC controller, the company responsible for the installation or the operation of the set must be contacted.

DEIF A/S reserves the right to change any of the contents of this document without prior notice.

The English version of this document always contains the most recent and up-to-date information about the product. DEIF does not take responsibility for the accuracy of translations, and translations might not be updated at the same time as the English document. If there is a discrepancy, the English version prevails.

Copyright

© Copyright DEIF A/S 2020. All rights reserved.

2. Safety instructions

2.1 General safety instructions

This document includes important instructions that should be followed during installation and maintenance of the controller.

Installation and maintenance must only be carried out by authorised personnel, and always in accordance with all applicable state and local electrical codes. Efficient and safe operation of the controller can be acquired only if the equipment is correctly operated, configured and maintained.

The following notations found in this document can indicate potentially hazardous conditions to the operator, service personnel or the equipment.

NOTE Highlights an essential element of a procedure to ensure correctness.



CAUTION

Indicates a procedure or practice, which could result in damage or destruction of equipment, if not strictly observed.



WARNING

Indicates a procedure or practice, which could result in injuring personnel or loss of life, if not followed correctly.

2.2 Electrical safety

- Electric shock can cause severe personal injury or death.
- Ensure that the genset is grounded before performing any installation or service.
- Generators produce high electrical voltages, and direct contact with it can cause fatal electrical shock. Prevent contact with terminals, bare wires, connections, etc., while the generator and related equipment are running. Do not tamper with interlocks.
- To handle the maximum electrical current, the wires used for electrical connections and wirings must be of appropriate size.

2.3 In operation safety

- Before installing the controller, ensure that all power voltage supplies are positively turned off at the source. Disconnect the generator's battery cables and remove the panel fuse to prevent accidental start up. Disconnect the cable from the battery post, indicated by a NEGATIVE, NEG, or (–) first. Reconnect the negative cable last. Failure to do so will result in hazardous and possibly fatal electrical shock.
- Remove the electric power supply before removing the controller or touching other electrical parts.
- Use extreme caution when working on electrical components. High voltage can cause injury or death.
- With floors of metal or concrete, use rubber insulation mats placed on dry wood platforms when working near the generator or other electrical equipment.
- Do not wear damp clothing (particularly wet shoes) or allow skin surface to be damp when handling electrical equipment.
- Do not operate any electrical device or wires while standing in water, while barefoot, or while hands or feet are wet. It may result in severe electrical shock.
- Do not wear jewellery. Jewellery can cause a short circuit within electrical contacts and cause shock or burning.

In case of an accident caused by electric shock, immediately shut down the electrical power source. If this is not possible, try to release the victim from the live conductor. Avoid direct contact with the victim. Use a non-conducting object (for example a rope or a wooden stick) to release the victim from the live conductor. If the victim is unconscious, apply first aid and get immediate medical help.

3. Technical specifications

3.1 Terminals

The SGC 110 uses two types of terminal blocks:



Connectors of 3.5 mm pitch

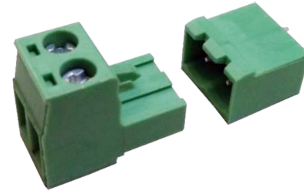

Connectors of 5.08 mm pitch

Table 3.1 Terminals

Connector type	Pitch	Male (on controller)*	Female (mating part)*	Quantity
4-pin	3.5 mm	5441294	5441223	2
6-pin	3.5 mm	5441317	5441249	1
8-pin	3.5 mm	5441320	5441252	1
10-pin	3.5 mm	5443962	5447560	1
2-pin	5.08 mm	5447353	5441980	1
4-pin	10.16 mm	5474274	5453499	1

*Note: Phoenix (Phoenix Contact (I) Pvt. Ltd.)

3.2 Power supply

Category	Specification
Controller terminals	1 (Ground) 2 (Battery or DC+)
Supply voltage range	Nominal voltage: 12/24 V DC Operating range: 8 to 28 V DC
Cranking drop out period	50 ms
Maximum reverse voltage protection	-32 V DC
Measurement accuracy (battery voltage)	±1 % full scale
Resolution	0.1 V
Maximum current consumption	~ 200 mA, 12/24 V DC (excluding the current load for the DC outputs)
Standby current consumption (LCD backlight off)	124 mA, 12 V DC 123 mA, 24 V DC
Deep sleep current	20 mA, 12/24 V DC

3.3 Genset voltage and frequency measurements

Category	Specifications
Controller terminals	27 (Neutral) 28 (L3) 29 (L2) 30 (L1)
Measurement type	True RMS
Phase-to-neutral voltage	32 to 300 V AC RMS
Phase-to-phase voltage	32 to 520 V AC RMS
Voltage accuracy	±2 % of full scale for phase-to-phase
Voltage resolution	1 V AC RMS for phase-to-neutral 2 V AC RMS for phase-to-phase
Frequency range	5 to 75 Hz
Frequency accuracy	0.25 % of full scale
Frequency resolution	0.1 Hz

NOTE For single phase applications, it is mandatory to connect the genset phase and neutral cables to the genset controller's phase L1 and neutral terminals.

3.4 Digital inputs

Category	Specifications
Controller terminals	10, 11, 12, 21, 22
Number of inputs	5
Type	Negative sensing (connect to ground for activation)
Software configurable options	Low Lub Oil Pressure (LLOP) Switch, High Water Temperature, and more (see Controller overview , Configurable parameters in the User manual for more details).

3.5 Analogue resistive sensor inputs

Category	Specifications
Controller terminals	24 (Engine temperature) 25 (Fuel level sensor) 26 (Oil pressure)
Number of inputs	3
Type	Ratio-metric sensing
Range	10 to 5000 Ω (terminal 24) 10 to 1000 Ω (terminal 25 and 26)
Open circuit detection	Above 5.5 k Ω (terminal 24) Above 1.5 k Ω (terminal 25 and 26)
Measurement accuracy	±2% of full scale (up to 1000 Ω)
Connection method	Connect the sensor output terminals between the genset controller terminal and the battery ground terminal

SCP connection

SCP connections for Analogue inputs 1 to 3*:

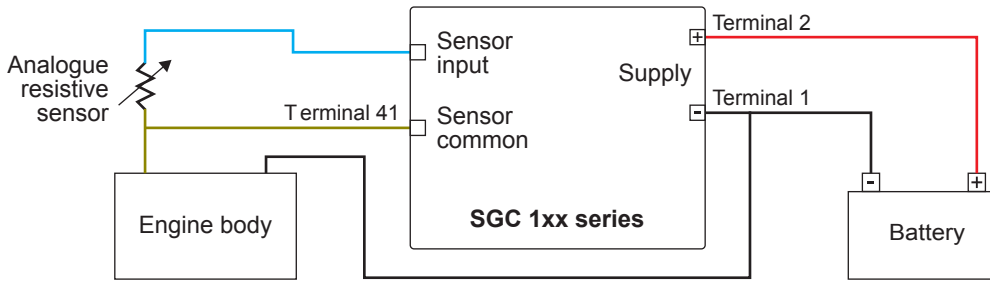

*SCP connections for Analogue input 2 used as *Fuel level sensor* with the reference configured as *Battery Negative*

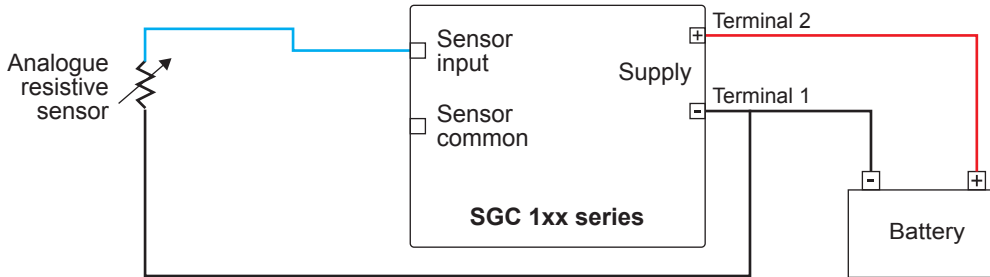

3.6 Analogue inputs used as digital inputs

Analogue inputs can be used as digital inputs when wired as shown.

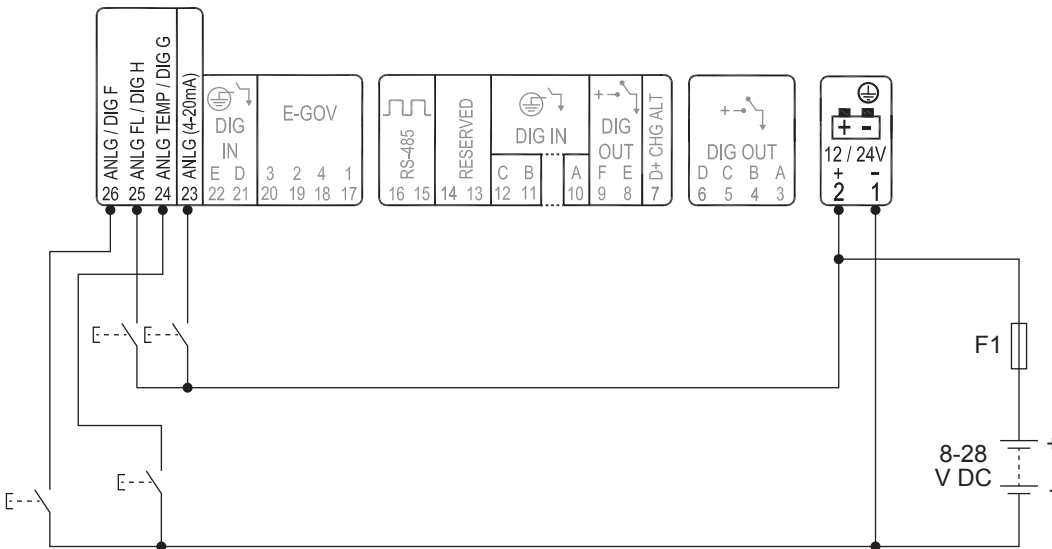

3.7 D+ Charger alternator

Category	Specifications
Controller terminal	7
Voltage range	0 to V_{BATT} $V_{BATT} = 8$ to 28 V DC
Excitation	PWM (power limited to 3 W, 12 V/250 mA)
Accuracy	± 1 % of full scale

The charge fail is a combined input and output terminal. When the genset starts, the terminal provides controlled power output to excite the charging alternator. After the excitation is successfully done, the controller reads the charging alternator's output voltage for monitoring its health. The action for charge fail is configurable.

3.8 Sensor common point

Category	Specifications
Controller terminal	41
Range	± 2 V
Accuracy	± 2 % of full scale

NOTE The sensor common point (SCP) terminal 41 of the controller should be directly connected to an electrically sound point on the engine body. This point on the engine body should serve as a common reference point for all analogue sensors such as those for measuring lube oil pressure, engine temperature and fuel level. The electrical cable used for the connection should not be shared with any other electrical connection. Such a wiring practice is strongly recommended to ensure that there is negligible potential difference, if any, between the engine body and the controller's SCP terminal, and, predictable and accurate analogue sensor measurements are always available in a wide variety of field conditions.

3.9 Digital outputs

Category	Specifications
Controller terminals	3, 4, 5, 6, 8, 9
Number of outputs	6
Type	DC outputs
Maximum current rating	Max. per output: 500 mA Total max.: 1 A
Software configurable options	Start relay, Fuel relay and many more (see Controller overview , Configurable parameters for more details).

NOTE

- Do not connect the starter motor relay and the stop solenoid directly to the controller's output terminals.
- Genset and mains contactor latching relays should be compiled against 4 kVA surge as per IEC-61000-4-5 standard.

3.10 Communication ports

Category	Specifications
USB	USB 2.0 type B for connection to PC with DEIF Smart Connect software.

4. Installation

4.1 Dimensions

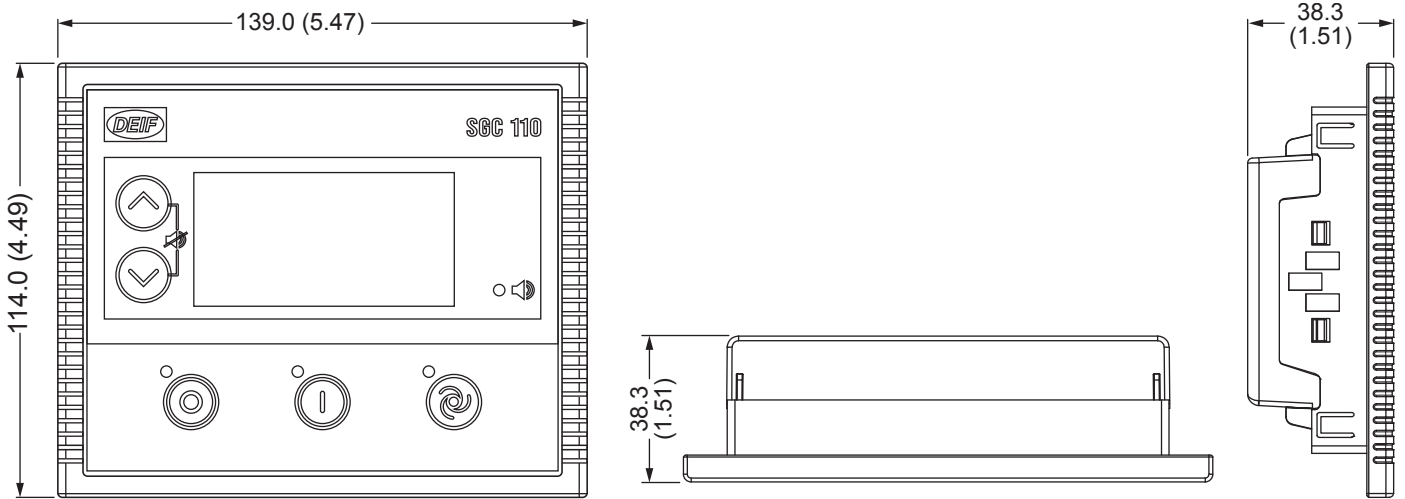

	Length	Height	Depth
Controller	139.0 mm (5.47 in)	114.0 mm (4.49 in)	38.3 mm (1.51 in)
Panel cut-out	118.0 mm (4.65 in)	93.0 mm (3.66 in)	Tolerance: ± 0.3 mm (0.01 in)

4.2 Mounting in panel

To mount the controller into the panel, use the fixing clips provided along with the controller.

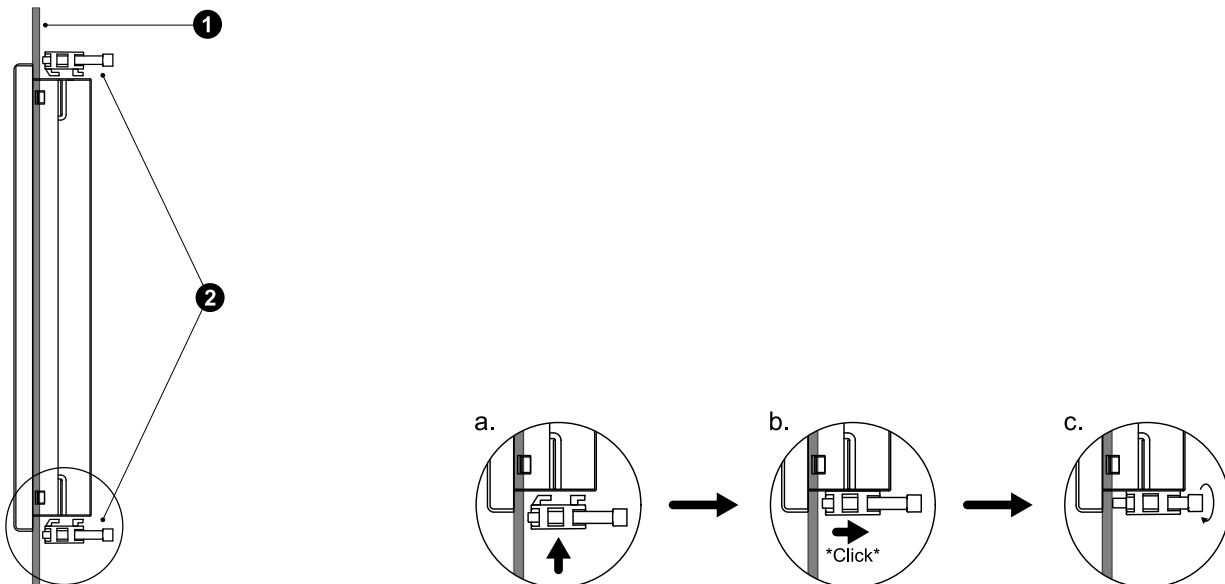

1. Panel surface.
2. Mounting clips.

- a. Insert the mounting clips into the slots on the controller.
- b. Press the mounting clips backwards until they "click" in place.
- c. Turn the screws to tighten the mounting clips (max. torque: 0.19 Nm).



CAUTION

Over-tightening the screw may damage the controller casing.

4.3 Terminal details

Rear view of the controller with terminal details.

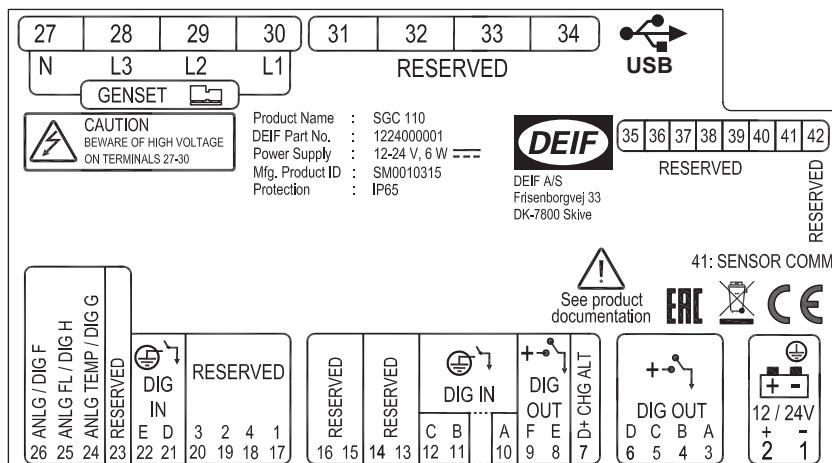

Terminal	Text	Description	Phoenix connector
1	GND	Power ground	5441980
2	BATT +	Power supply positive	
3	DIG OUT A	DC output - A	
4	DIG OUT B	DC output - B	
5	DIG OUT C	DC output - C	5441223
6	DIG OUT D	DC output - D	
7	D+ CHG ALT	Input for charging alternator control	
8	DIG OUT E	DC output - E	
9	DIG OUT F	DC output - F	5441223
10	DIG IN A	Input from switch - A	
11	DIG IN B	Input from switch - B	
12	DIG IN C	Input from switch - C	
13	Reserved	-	
14	Reserved	-	5441249
15	Reserved	-	
16	Reserved	-	
17	Reserved	-	
18	Reserved	-	
19	Reserved	-	
20	Reserved	-	
21	DIG_IN D	Input from switch - D	
22	DIG_IN E	Input from switch - E	5447560
23	Reserved	-	
24	ANLG_IN ENG_TEMP	Analogue input from Engine temperature sensor	
25	ANLG_IN FUEL_LEVEL	Analogue input from Fuel level sensor	
26	ANLG_IN LOP	Analogue input from Lube oil pressure sensor	

Terminal	Text	Description	Phoenix connector
27	GEN_V-IN NTRL	Voltage input from Generator Neutral	5453499
28	GEN_V-IN L3	Voltage input from Generator phase L3	
29	GEN_V-IN L2	Voltage input from Generator phase L2	
30	GEN_V-IN L1	Voltage input from Generator phase L1	
31	Reserved	-	
32	Reserved	-	
33	Reserved	-	
34	Reserved	-	
35	Reserved	-	5441456
36	Reserved	-	
37	Reserved	-	
38	Reserved	-	
39	Reserved	-	
40	Reserved	-	
41	SCP	Sensor common point	
42	Reserved	-	

4.4 Typical wiring diagram

Figure 4.1 SGC 110 typical wiring

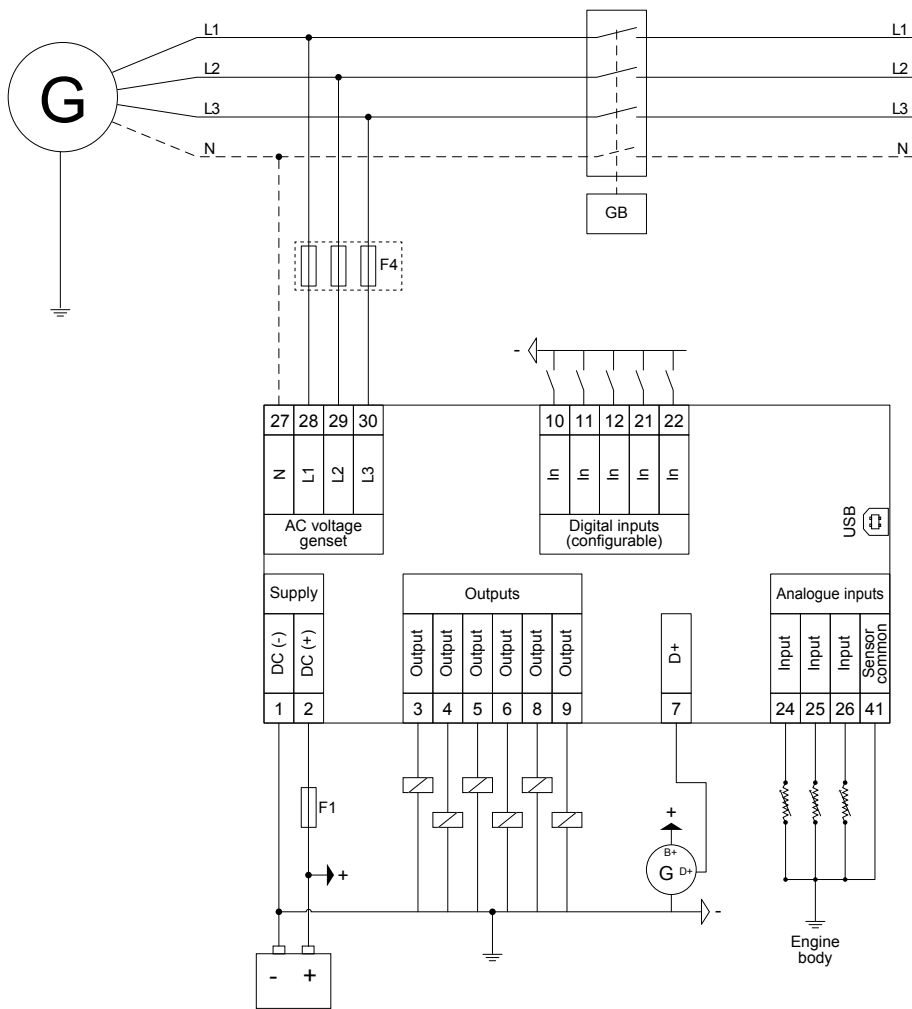



- NOTE**
- Fuses:
 - F1: 5 A
 - F4: 2 A
 - Wiring diagrams are examples. Use the application's wiring diagram during installation.
 - Genset and mains contactor latching relays should be compiled against 4 kV surge as per IEC-61000-4-5 standard.
 - Relay cards used with the controller should be protected against reverse battery voltages.
 - Analogue input 2 used for *Fuel level sensor* can be wired with the reference to *Battery Negative*, see **Specifications, Analogue resistive sensor inputs**.
 - If a digital output is connected to a relay, the relay must include freewheeling diodes.

5. Monitoring mode

5.1 Monitoring mode

In Monitoring mode, the display views shift automatically after a pre-defined time. This delay time can be configured in the configuration menu.

The views can also be changed manually with the *Up*  and *Down*  buttons.

Engine status and operating mode

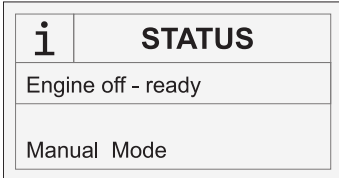

Manual mode

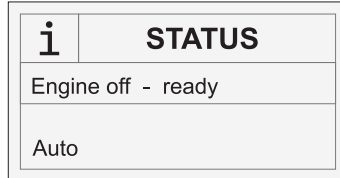

Auto mode

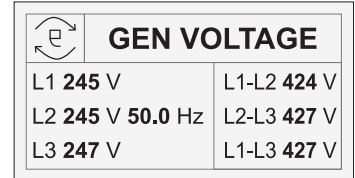

Generator voltage

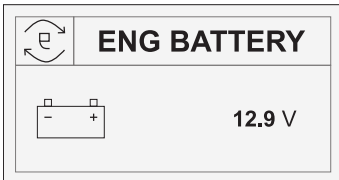

Engine battery voltage

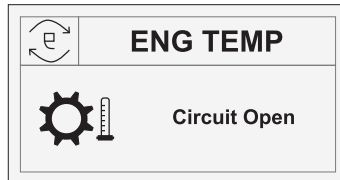

Engine temperature

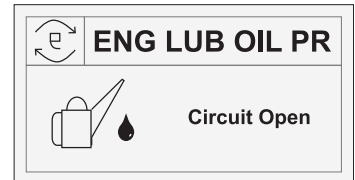

Engine lube oil pressure

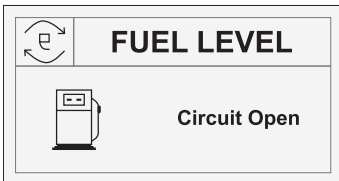

Engine remaining fuel

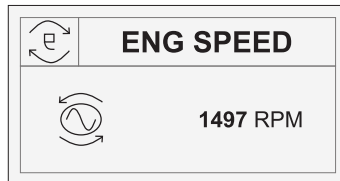

Engine speed

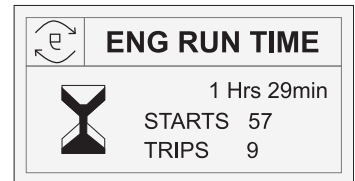

Engine run time



Alarms (example)



Product info



6. Configuration mode

6.1 Configuration mode



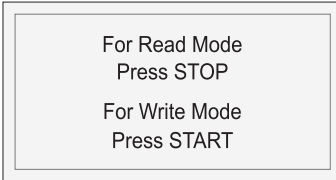

To configure the controller, follow these steps:

1. Press and hold the *Stop/Config*  button for at least three seconds.
2. The display shows



3. To see the configuration, press the *Stop/Config*  button. To change the configuration, press the *Start*  button.
4. The display shows



5. To enter the the four digit password:
 - Scroll through the digits with the *Up*  and *Down*  buttons.
 - Select a digit with the *Start*  button.
6. To leave the Configuration mode, press and hold the *Stop/Config*  button.
7. Until the configuration is saved, the display shows

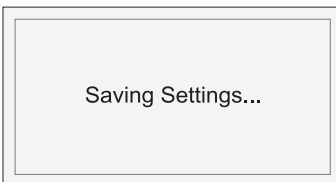

6.2 Configurable parameters

6.2.1 Configurable parameters

The tables give an overview of configurable parameters.

Level 1 (table titles) and Level 2 texts are shown twice:

- DEIF Smart Connect software: Normal sentence case, for example Power on Mode.
- Controller display: Capital case in brackets, for example (POWER ON MODE)

6.2.2 Module

Table 6.1 General (GENERAL)

Level 2	Range
Profile name	Profile 1
Power on Mode (POWER ON MODE)	Manual Auto
Power on Lamp Test (POWER ON LAMP TEST)	Enable Disable
Deep Sleep Mode (DEEP SLEEP MODE)	Enable Disable
Auto-Clear Warning Alarm (AUTO CLEAR WARNINGS)	Enable Disable
Language (LANGUAGE SUPPORT)	English Chinese

Table 6.2 Display (DISPLAY)

Level 2	Range
Contrast (CONTRAST)	0 to 100 %
Power Save Mode (POWER SAVE MODE)	Enable Disable

6.2.3 Digital inputs

Table 6.3 Digital Input # (DIG IN #)

Level 2	Range
Source (SOURCE)	See Digital input source selection in this document
Name (NAME)	Auxiliary Input #
Polarity (POLARITY)	Close to Activate Open to Activate
Action (ACTION)	None Notification Warning Electrical Trip Shutdown
Activation (ACTIVATION)	Never From Engine Start From Monitoring On Always
Activation Delay (ACTIVATION DELAY)	0 to 60 s

6.2.4 Analogue inputs

Table 6.4 Analogue Input 1 (ENG TEMP / DIG G)

Level 2	Range
Use Input As (SENSOR SELECTION)	Not used Digital Input G Engine Coolant Temperature Sensor
(Digital) Source ((DIG) SOURCE)	See Digital input source selection in this document
Name (NAME)	Auxiliary Input G
(Digital) Polarity ((DIG) POLARITY)	Close to Activate Open to Activate
(Digital) Action ((DIG) ACTION)	None Notification Warning Electrical Trip Shutdown
(Digital) Activation ((DIG) ACTIVATION)	Never From Engine Start From Monitoring On Always
(Digital) Activation Delay ((DIG) ACTIVATION DELAY)	1 to 60 s
(ETS) Circuit Fault Action (OPEN CKT ALARM)	None Notification Warning Electrical Trip Shutdown
(ETS) Engine Temperature Sensor Calibration Table	Resistance: 0 to 1000 Ω Temperature: 25 to 300 $^{\circ}\text{C}$

Table 6.5 Analogue Input 2 (FUEL LVL / DIG H)

Level 2	Range
Use Input As (SENSOR SELECTION)	Not used Digital Input H Fuel Level Sensor
(Digital) Source ((DIG) SOURCE)	See Digital input source selection in this document
Name (NAME)	Auxiliary Input H
(Digital) Polarity ((DIG) POLARITY)	Close to Activate Open to Activate
(Digital) Action ((DIG) ACTION)	None Notification Warning Electrical Trip Shutdown
(Digital) Activation ((DIG) ACTIVATION)	Never From Engine Start

Level 2	Range
	From Monitoring On Always
(Digital) Activation Delay (DIG) ACTIVATION DELAY)	1 to 60 s
(FLS) Low Fuel Level Shutdown (SHUTDOWN)	Enable Disable
(FLS) Shutdown Threshold (SHUTDOWN THRESHOLD)	0 to 78 %
(FLS) Low Fuel Level Notification (NOTIFICATION)	Enable Disable
(FLS) Notification Threshold (NOTIFICATION THRESHOLD)	2 to 80 %
(FLS) Fuel Tank Capacity (FUEL TANK SIZE)	2 to 1000 litre
(FLS) Fuel Theft Warning (FUEL THEFT ALARM)	Enable Disable
(FLS) Fuel Theft Alarm Threshold (FUEL LVL THRESH)	1 to 100 % per hour
(FLS) Circuit Fault Action (OPEN CKT ALARM)	None Notification Warning Electrical Trip Shutdown
(FLS) Fuel Sensor Reference (FUEL LVL REF)	Battery Negative Engine Body
(FLS) Fuel Level Sensor Calibration Table	Resistance: 0 to 1000 Ω Fuel level: 0 to 100 %

Table 6.6 Analogue Input 3 (LOP / DIG F)

Level 2	Range
Use Input As (SENSOR SELECTION)	Not used Digital Input F Lube Oil Pressure
(Digital) Source (DIG) SOURCE)	See Digital input source selection in this document
Name (NAME)	Auxiliary Input F
(Digital) Polarity (DIG) POLARITY)	Close to Activate Open to Activate
(Digital) Action (DIG) ACTION)	None Notification Warning Electrical Trip Shutdown
(Digital) Activation (DIG) ACTIVATION)	Never From Engine Start From Monitoring On Always

Level 2	Range
(Digital) Activation Delay (DIG) ACTIVATION DELAY)	1 to 60 s
(LOP) Circuit Fault Action (OPEN CKT ALARM)	None Notification Warning Electrical Trip Shutdown
(LOP) Lube Oil Pressure Sensor Calibration	Resistance: 10 to 100 Ω Pressure: 1.0 to 10.0 bar

6.2.5 Outputs

Table 6.7 Outputs # (OUT #)

Level 2	Range
Source (SOURCE)	See Digital output source selection in this document
On Activation (ON ACTIVATION)	Energise De-energise

6.2.6 Timers

Table 6.8 Cranking (CRANKING TIMERS)

Level 2	Range
Crank Hold Time (CRANK HOLD TIME)	1 to 15 s
Crank Rest Time (CRANK REST TIME)	2 to 60 s
Manual Start Delay (MANUAL START DELAY)	0 to 300 s
Auto Start Delay (AUTO START DELAY)	0 to 43200 s

Table 6.9 General (GENERAL TIMER)

Level 2	Range
Safety Monitoring Delay (SAFETY MONITOR DELAY)	10 to 60 s
Mains Detect Delay (MAINS DETECT DELAY)	N/A
Alternator Detect Delay (ALT DETECT DELAY)	1 to 30 s
Warm-Up Delay (WARM-UP DELAY)	0 to 60 s
Return To Mains Delay (RETN-TO-MAINS DELAY)	N/A
Engine Cooling Time (ENG COOL TIME)	0 to 300 s

Level 2	Range
Stop Action Time (STOP ACTION TIME)	10 to 120 s
Additional Stopping Time (ADDN STOPPING TIME)	0 to 120 s
Load Transfer Delay (LOAD TRANSFER DELAY)	0 to 60 s
Power Save Mode Delay (PWR SAVE MODE DELAY)	5 to 1800 s
Screen Changeover Time (SCRN CHNGOVER TIME)	1 to 1800 s
Deep Sleep Mode Delay (DEEP SLP MODE DELAY)	5 to 1800 s
Sounder Alarm Time (SOUNDER ALARM TIMER)	1 to 300 s
Auto Exit Config Mode (AUTO EXIT CNFG MODE)	10 to 1800 s

6.2.7 Generator

Table 6.10 Alternator configuration (ALT CONFIG)

Level 2	Range
Alternator Present (ALT PRESENT)	Yes No
Number of Poles (NUMBER OF POLES)	2/4/6/8
AC system (ALT AC SYSTEM)	1 phase 3 phase
Min Healthy Voltage (MIN HEALTHY VOLT)	50 to 350 V phase-neutral
Min Healthy Frequency (MIN HEALTHY FREQ)	10 to 75 Hz
Phase Reversal Detection (PHASE REVERSAL DETECT)	Enable Disable
Phase Reversal Action (PHASE REVERSAL ACTION)	None Notification Warning Electrical Trip Shutdown
Auto Load Transfer (AUTO LOAD TRANSFER)	Enable Disable

Table 6.11 Voltage Monitoring (VOLT MONITOR)

Level 2	Range
Under-voltage Shutdown (UNDER VOLT SHUTDOWN)	Enable Disable
Under-voltage Shutdown Threshold (UV SHUTDOWN THRESH)	50 to 295 V phase-neutral

Level 2	Range
Under-voltage Warning (UNDER VOLT WARNING)	Enable Disable
Under-voltage Warning Threshold (UV WARNING THRESHOLD)	55 to 300 V phase-neutral
Over-voltage Shutdown (OVER VOLT SHUTDOWN)	Enable Disable
Over-voltage Shutdown Threshold (OV SHUTDOWN THRESH)	105 to 350 V phase-neutral
Over-voltage Warning (OVER VOLT WARNING)	Enable Disable
Over-voltage Warning Threshold (OV WARNING THRESHOLD)	100 to 345 V phase-neutral

Table 6.12 Frequency Monitoring (FREQ MONITOR)

Level 2	Range
Under-frequency Shutdown (UNDER FREQ SHUTDOWN)	Enable Disable
Under-frequency Shutdown Threshold (UF SHUTDOWN THRESH)	10.0 to 59.0 Hz
Under-frequency Warning Enable (UNDER FREQ WARNING)	Enable Disable
Under-frequency Warning Threshold (UF WARNING THRESHOLD)	11.0 to 60.0 Hz
Over-frequency Shutdown Enable (OVER FREQ SHUTDOWN)	Enable Disable
Over-frequency Shutdown Threshold (OF SHUTDOWN THRESH)	26.0 to 75.0 Hz
Over-frequency Warning Enable (OVER FREQ WARNING)	Enable Disable
Over-frequency Warning Threshold (OF WARNING THRESHOLD)	25.0 to 74.0 Hz

6.2.8 Engine

Table 6.13 Crank Disconnect (CRANK DISCONN)

Level 2	Range
Start Attempts (START ATTEMPTS)	1 to 9
Disconnect on Oil Pressure Sensor (DISCONN ON LOP SENS)	Enable Disable
Monitor Pressure Sensor Before Crank (MON LLOP BEF CRANK)	Enable Disable
Pressure Sensor Monitoring Threshold (DISCONN LOP SENS)	0.5 to 10.0 bar
Monitor Pressure Switch Before Crank (MON LOP BEF CRANK)	Enable Disable

Level 2	Range
Disconnect on Oil Pressure Switch (DISCONN ON LLOP SW)	Enable Disable
Pressure Switch Transient Time (LLOP SW TRANS TIME)	0.0 to 3.0 s
Crank Disconnect At Alt Frequency (ALT FREQUENCY)	10 to 70 Hz
Crank Disconnect At Engine Speed (ENGINE SPEED)	150 to 4000 RPM
Disconnect On Charging Alt Voltage (DISC ON CHG ALT VOLT)	Enable Disable
Charging Alt Disconnect Volt Threshold (CHG ALT THRESHOLD)	5.0 to 30.0 V

Table 6.14 Speed Monitoring (SPEED MONITOR)

Level 2	Range
Engine Speed Sense Source (SPEED SENSE SOURCE)	Alternator frequency
Flywheel Teeth (Magnetic Pickup)	N/A
W-Point Frequency@ 1500	N/A
Under-speed Shutdown (UNDER SPEED SHUTDOWN)	Enable Disable
Under-speed Threshold (UNDER SPEED THRESH)	0 to 3600 RPM
Under-speed Delay (UNDER SPEED DELAY)	1 to 60 s
Over-speed Threshold (OVER SPEED THRESH)	700 to 4000 RPM
Over-speed Delay (OVER SPEED DELAY)	1 to 20 s
Gross Over-speed Threshold (GROSS OS THRESHOLD)	100 to 200 %

Table 6.15 Battery Monitoring (BATTERY MONITOR)

Level 2	Range
Low Battery Voltage Action (LOW VOLT ACTION)	None Notification Warning Electrical Trip Shutdown
Low Battery Voltage Threshold (LOW VOLT THRESHOLD)	8.0 to 31.0 V
Low Battery Voltage Delay (LOW VOLT DELAY)	5 to 1800 s
High Battery Voltage Action (HIGH VOLT ACTION)	None Notification Warning Electrical Trip

Level 2	Range
	Shutdown
High Battery Voltage Threshold (HIGH VOLT THRESHOLD)	9.0 to 32.0 V
High Battery Voltage Delay (HIGH VOLT DELAY)	5 to 1800 s

Table 6.16 Charging Alternator Monitoring (CHARGE ALT MON)

Level 2	Range
Charging Alternator Fail Action (FAIL ACTION)	None Notification Warning Electrical Trip Shutdown
Charging Alternator Fail Threshold (FAIL THRESHOLD)	0.0 to 35.0 V
Charging Alternator Fail Delay (FAIL DELAY)	5 to 60 s

Table 6.17 Preheating (PREHEAT)

Level 2	Range
Pre-heat Timer (PREHEAT TIMER)	1 to 900 s
Engine Temperature (ENG TEMP EN)	Enable Disable
Engine Temperature Threshold (ENG TEMP LIMIT)	10 to 300 °C

6.2.9 Maintenance

Table 6.18 Maintenance (MAINT ALARM)

Level 2	Range
Alarm Action (ACTION)	None Notification Warning
Due At Engine Hours (DUE AT ENGINE HOURS)	10 to 65000 hours
Alarm Due Date (ALARM DUE DATE)	dd/mm/yyyy

6.2.10 Password ID

Table 6.19 ID

Level 1	Level 2	Range
(PASSWORD 1)	####	Numbers: 0 to 9
(PASSWORD 2)	####	Numbers: 0 to 9

6.3 Digital input source selection

No.	Input source
1	Not Used
2	User Configured
3	Low Fuel LVL Switch
4	Low Lube Oil Press Switch
5	High Engine Coolant Temp Switch
6	Low Water LVL Switch
7	Emergency Stop
8	Remote Start/Stop
9	Simulate Start
10	Simulate Stop
11	Simulate Auto
12	Close Gen/Open Mains Switch
13	Close Mains/Open Gen Switch
14	Reserved1
15	V-Belt Broken Switch

6.4 Digital output source selection

No.	Output source
1	Disable
2	Sounder Alarm
3	Battery Over Volt
4	Battery Under Volt
5	Charge Alt Shutdown
6	Charge Alt Warning
7	Configurable
8	Configurable
9	Reserved1
10	Common Alarm
11	Common Electrical Trip
12	Common Shutdown
13	Common Warning
14	Cooling Down
15	Dig In A
16	Dig In B
17	Dig In C
18	Dig In D
19	Dig In E

No.	Output source
20	Dig In F (Anlg In LOP 1)
21	Dig In G (Analog Eng Temp)
22	Dig In H (Anlg In Fuel LVL)
23	Reserved2
24	Emergency Stop
25	Stop Solenoid
26	Fail To Start
27	Fail To Stop
28	Fuel Relay
29	Gen Available
30	L1 Phase OV Shutdown
31	L1 Phase UV Shutdown
32	L2 Phase OV Shutdown
33	L2 Phase UV Shutdown
34	L3 Phase OV Shutdown
35	L3 Phase UV Shutdown
36	Reserved3
37	High Engine Coolant Temp
38	Low Fuel LVL
39	Low LOP
40	Reserved4
41	Reserved5
42	Oil Pressure Open Circuit
43	Open Gen Contactor
44	Configurable
45	Over Freq Shutdown
46	Over Speed Shutdown
47	Gross Over Speed Shutdown
48	Start Relay
49	Temp Sensor Open Circuit
50	Under Freq Shutdown
51	Under Speed Shutdown
52	Maintenance Due
53	Stop Mode
54	Auto Mode
55	Manual Mode
56	Preheat Output

7. Running modes

7.1 Remote start/stop mode

To use the Remote start/stop mode, configure one of the digital input as Remote start/stop (Latched type input) and set the controller to Auto mode.

To start or stop the genset while in Remote start/stop mode, activate/deactivate (continuous signal) the pre-configured Remote start/stop input. The controller latches the genset contactor when the controller confirms that all the engine and genset parameters are within the configured thresholds. When the pre-configured input is deactivated the controller opens the genset contactor.

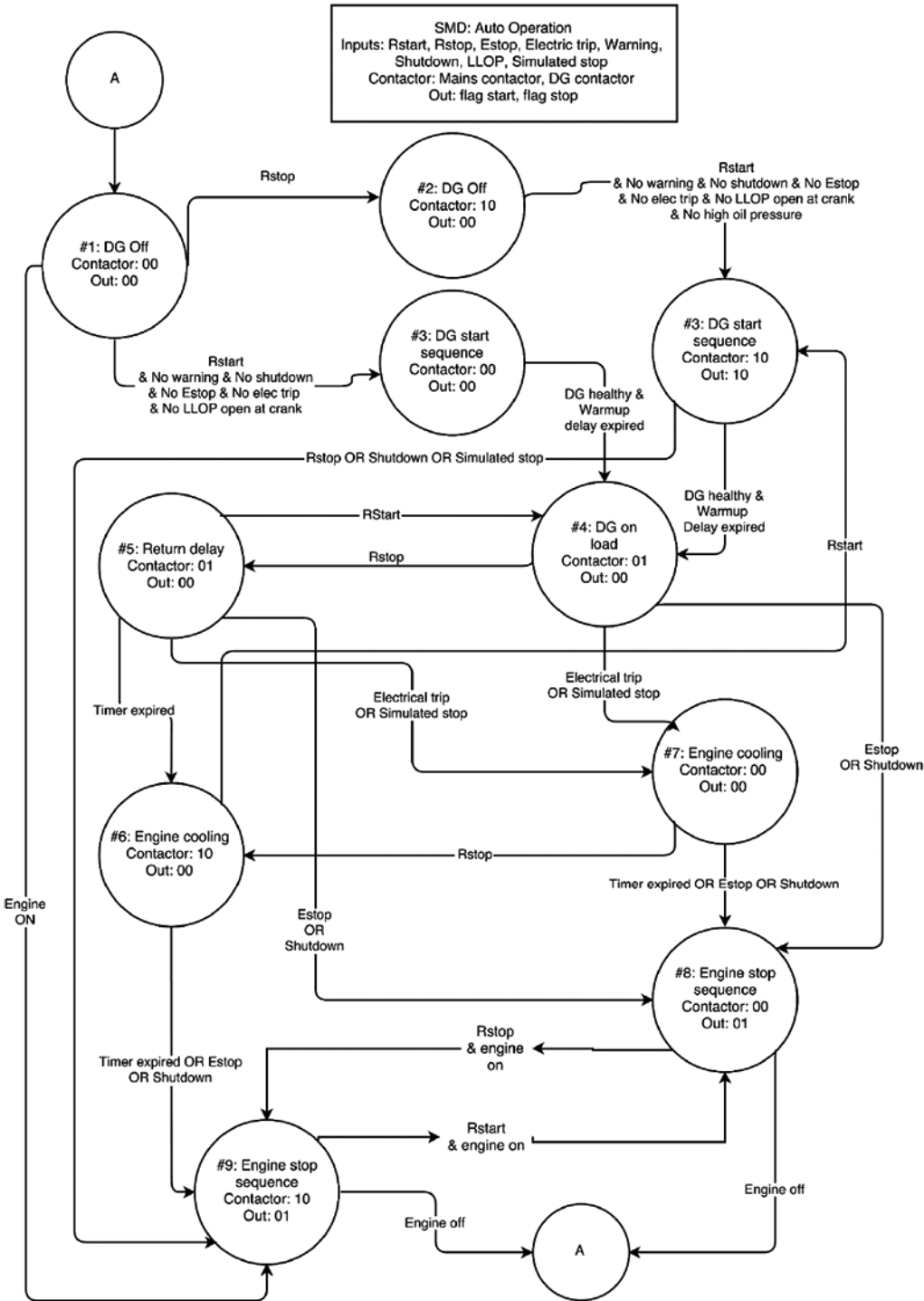

7.2 Deep sleep mode

Deep sleep mode is a useful feature to prolong the battery life. In this mode, normal functions of the controller are suspended and the controller is placed in its lowest power consumption state. The controller maintains the status and alarms it had before Deep sleep mode. When the controller wakes up, normal operations are resumed automatically.

The controller goes in Deep sleep mode when there is no user interaction for the preset Deep sleep mode delay. In Auto mode, if Remote start/stop is configured to a digital input, the controller wakes up after receiving a Remote start command.

Press and hold any key for at least one second to come out of Deep sleep mode.

7.3 Manual mode

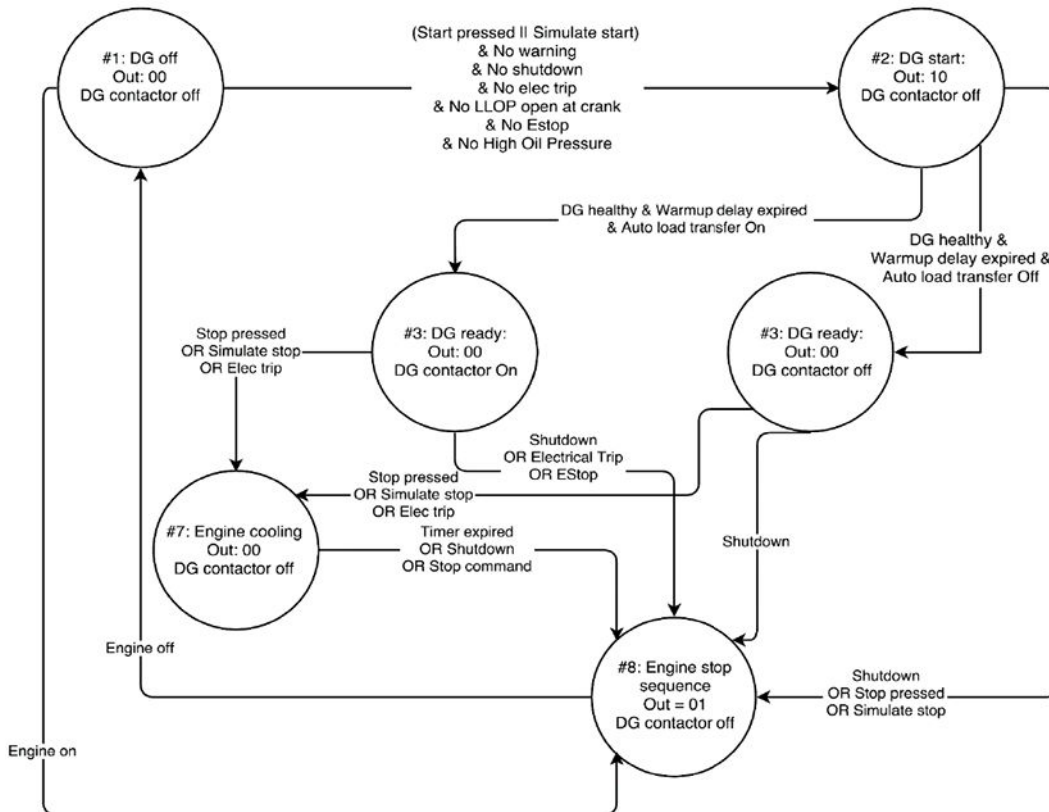

- Inputs: Stop pressed, Start pressed, Simulate start, Simulate stop, Estop, Electric trip, Shutdown, Warning, LLOP, Auto load transfer.
- Outputs: flag_start, flag_stop.

8. Alarms

8.1 Alarms

With SGC 110 it is possible to configure several Shutdown/Electrical trip, Warning and Notification alarms, for example Low oil pressure shutdown, Overload warning, and more.

An alarm occurs when a pre-configured parameter is out of the preset level. The Alarm LED flashes and the Sounder alarm activates (if configured). The controller shows the alarm names on the Alarms display and the nature of alarm on Engine status display.

To acknowledge the alarms, press the *Up*  and *Down*  buttons simultaneously.

All the alarms are activated at the end of Safety monitoring timer. The controller will not send the start command if Warning, Electrical trip or Shutdown alarms are left unacknowledged.

Alarm types

No.	Alarm actions	Description
1	Shutdown	Load is taken off from the genset and the genset is immediately stopped by skipping the Engine cooling time.
2	Electrical trip	Load is taken off from the genset, the Engine cooling timer begins, after which the genset is stopped.
3	Warning	Warning alarms draw the operator's attention to an undesirable condition without affecting the genset's operation. The genset cannot be started without acknowledging the Warning alarms
4	Notification	The controller shows the message on the display. The genset start/stop operation is not affected.

Alarms and their causes

No.	Alarms	Causes/Indication	Actions
1	Low Oil Pressure (Sensor)	Indicates that the oil pressure measured is below the preset threshold.	Shutdown Warning
	Low Oil Pressure (Switch)	Indicates that the oil pressure measured is low through switch.	Shutdown Warning Electrical Trip Notification
2	Low Fuel level sensor	Indicates that the amount of fuel level is below the preset threshold.	Shutdown Warning
	Low Fuel level switch	Indicates that the amount of fuel level is below the preset threshold.	Shutdown Warning Electrical Trip Notification
3	High Eng Temp sensor	Indicates that the engine temperature is above the preset threshold. This condition is detected only when engine is on.	Shutdown Warning
	High Eng Temp switch	Indicates that the engine temperature measured is high through switch.	Shutdown Warning Electrical Trip Notification

No.	Alarms	Causes/Indication	Actions
4	Low Water Level switch	Indicates that radiator water level is below the preset threshold.	Shutdown Warning Electrical Trip Notification
5	Over Speed	Indicates that genset speed has exceeded the preset overspeed threshold. The genset will shut down after Overspeed delay.	Shutdown
6	Gross Over Speed	Indicates that genset speed has exceeded the preset Gross overspeed threshold. The genset will shut down immediately without any delay.	Shutdown
7	Under Speed	The engine speed has fallen below the preset RPM.	Shutdown
8	L1 Phase Over Voltage	Indicates that genset (L1) phase voltage has exceeded the preset over-voltage threshold.	Shutdown Warning
9	L1 Phase Under Voltage	Indicates that genset (L1) phase voltage has fallen below preset under-voltage threshold.	Shutdown Warning
10	L2 Phase Over Voltage	Indicates that genset (L2) phase voltage has exceeded the preset over-voltage threshold.	Shutdown Warning
11	L2 Phase Under Voltage	Indicates that genset (L2) phase voltage has fallen below preset under-voltage threshold.	Shutdown Warning
12	L3 Phase Over Voltage	Indicates that genset (L3) phase voltage has exceeded the preset over-voltage threshold.	Shutdown Warning
13	L3 Phase Under Voltage	Indicates that genset (L3) phase voltage has fallen below preset under-voltage threshold.	Shutdown Warning
14	Over Frequency	Indicates that genset output frequency has exceeded the preset threshold.	Shutdown Warning
15	Under Frequency	Indicates that genset output frequency has fallen below the preset threshold.	Shutdown Warning
16	Emergency stop	Configured as digital input has triggered longer than preset duration or when the immediate shutdown is required.	Shutdown
17	Charge Fail	The charge alternator voltage has dropped below the preset threshold.	Shutdown Warning Notification
18	Battery Over Voltage	The battery voltage has exceeded the preset threshold.	Shutdown Warning Electrical Trip Notification
19	Battery Under Voltage	The battery voltage has fallen below the preset threshold.	Shutdown Warning Electrical Trip Notification
20	Maintenance due	Indicates that engine running hours exceed the preset hours limit or maintenance due date has occurred and filter servicing is required.	Warning Notification
21	Auxiliary input/User defined name	Configured auxiliary input has triggered longer than preset duration.	Shutdown Warning Electrical Trip Notification
22	Fail to Stop	It is detected that genset is still running after sending stop command.	Shutdown

No.	Alarms	Causes/Indication	Actions
23	Fail to Start	Indicates that genset has not started after the preset number of Start attempts.	Shutdown
24	Fuel theft	The fuel consumption exceeds the preset threshold.	Warning
25	Eng Temp/terminal 24 - Ckt Opn	The temperature sensor is not detected (circuit open).	Warning
26	Fuel Level Ckt Open	The fuel level sensor is not detected (circuit open).	Shutdown
27	LOP/terminal 26 - Ckt Opn	The oil pressure sensor is not detected (circuit open).	Warning
28	DG Phase Reversed	Alternator phase sequence (L1-L2-L3) is not correct.	Shutdown Warning Electrical Trip
29	High Oil Pressure sensor	Indicates that the measured oil pressure is above the preset threshold.	Shutdown Warning
	High Oil Pressure switch	Indicates that the measured oil pressure is above the preset threshold.	Shutdown Warning Electrical Trip Notification

9. Troubleshooting

9.1 Troubleshooting

This section explains the common faults, their possible causes and remedial actions.

General troubleshooting

Fault	Action
The controller does not power ON.	<ul style="list-style-type: none"> • Check the battery voltage. • Check the fuse on the battery supply. • Check continuity between battery positive and controller terminal 2. • Check continuity between battery ground and controller terminal 1.
The controller display freezes or hangs up.	<ul style="list-style-type: none"> • Reset the controller power.
The controller fails to crank-start the engine.	<ul style="list-style-type: none"> • Check the battery voltage. • Enter the Configuration mode in the controller and verify the configuration for the Start output. Check that the Start output is working correctly by measuring its output voltage. • Enter the Configuration mode in the controller and verify the configuration of the Crank disconnect method. • Verify the configuration of the LLOP Switch polarity. Ensure that the lube oil pressure switch and sensor are working OK. Check their wiring.
The Emergency Stop alarm is shown without the Emergency Stop is activated.	<ul style="list-style-type: none"> • Check if the Emergency stop switch is working OK, including the wiring. • Enter the Configuration mode in the controller and verify the configuration of the Emergency stop polarity.
The controller generates unnecessary Shutdown alarms or Warning alarms.	<ul style="list-style-type: none"> • Check the respective switch, sensor and wiring. • Enter Configuration mode in the controller and verify the respective threshold configuration.
The controller shows Charge fail alarm.	<ul style="list-style-type: none"> • To check if the controller's charging alternator terminal is working: <ul style="list-style-type: none"> ◦ Disconnect the charging alternator wiring to the controller's terminal 7. ◦ Short terminal 7 to the ground through a DC ammeter. ◦ Crank-start the engine. ◦ The DC ammeter should indicate the current in the range of 200 to 400 mA for ~30 seconds. ◦ If yes, the controller's charging alternator terminal is working OK. • Disconnect and re-connect the charging alternator connection to the controller's terminal 7. • Check if the charging alternator is working OK.
The controller shows Error C03.	<p>Error C03 can occur if the controller is disconnected from the PC during a configuration.</p> <ol style="list-style-type: none"> 1. Press and hold the <i>Stop/Config</i>  button during a power cycle to reset the controller. 2. Re-send the configuration file.
The controller shows genset ON while genset is at rest. Fail to stop alarm when genset is at rest.	<ul style="list-style-type: none"> • Enter Configuration mode in the controller and verify the configuration for the LLOP and LOP, including the wiring. • Ensure that Mains voltage wiring is not connected by mistake to the controller's genset voltage terminals.

Fault	Action
The controller sends a Crank-start command immediately after power on.	<ul style="list-style-type: none"> • Ensure that the controller's output terminal is not directly connected to the starter relay. The controller's output should be given to an intermediate relay which should in-turn power the starter relay. The controller can get permanently damaged and will need to be replaced if this precaution is not taken. • Check the start-relay connection with the suitable controller terminal. • Enter the Configuration mode in the controller and verify the configuration for Start mode and the Start relay output polarity.
The engine runs, but the controller shows genset to be OFF.	<ul style="list-style-type: none"> • Check if the alternator voltage signal (L1 phase) is received by the controller terminals. • Check if the LOP and LLOP are working OK, including the wiring to the controller.
The controller shows incorrect reading for any of LOP, fuel level or temperature sensors.	<ul style="list-style-type: none"> • Check the respective sensor and its wiring. • Enter the Configuration mode in the controller and verify the calibration for the respective sensor in the configuration.
The controller shows incorrect engine RPM.	Check the wiring from the main alternator's L1 phase and neutral to the controller.
The controller shows incorrect engine temperature/Lube oil pressure.	Check the wiring between the controller's terminal 41 (SCP) and the engine body
The controller shows incorrect fuel level.	Enter Configuration mode, check if the Fuel analogue input configuration for the Fuel sensor reference is like the physical connection. For example, if the configuration is set as Battery negative the connection of the fuel sensor negative must be on battery negative.